

IV. Modifying the counterpiece

Reference: **Grundplatte_2 – Project 3 Holder (5/5)**

1.

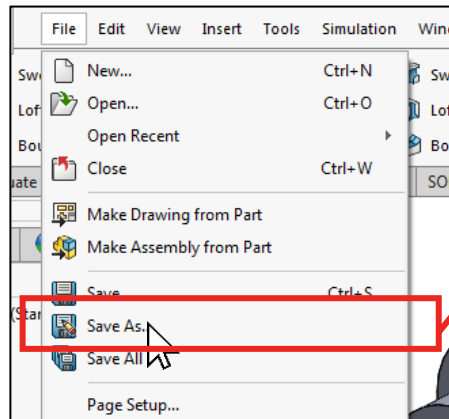
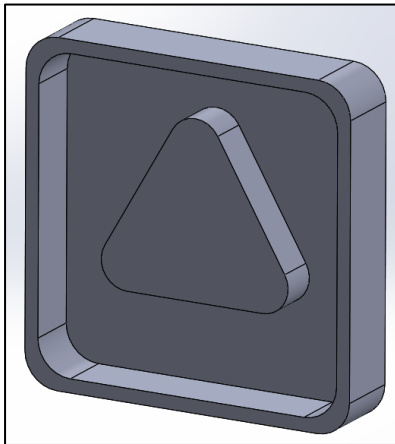

New File!

2. see I Nr. 2

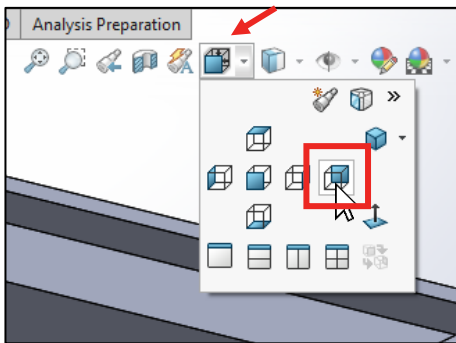

or



1-2x 

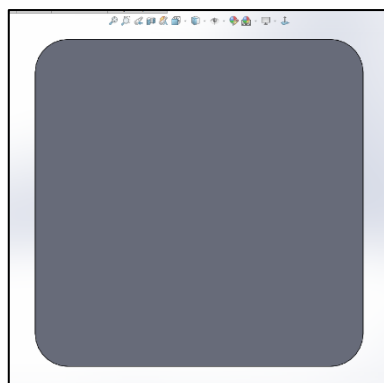

3.

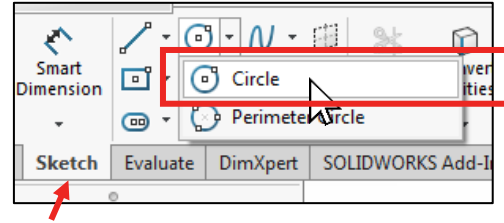
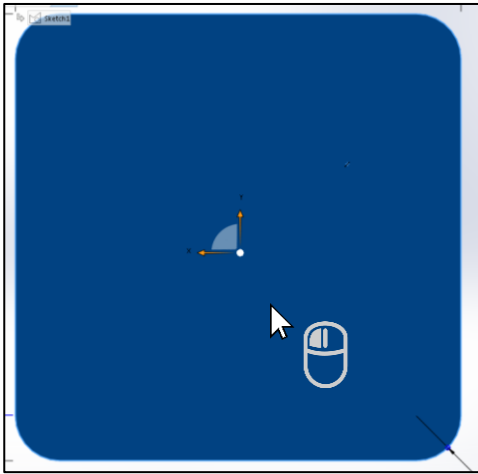

4.

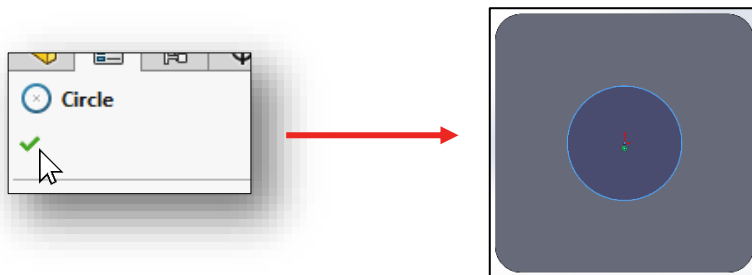
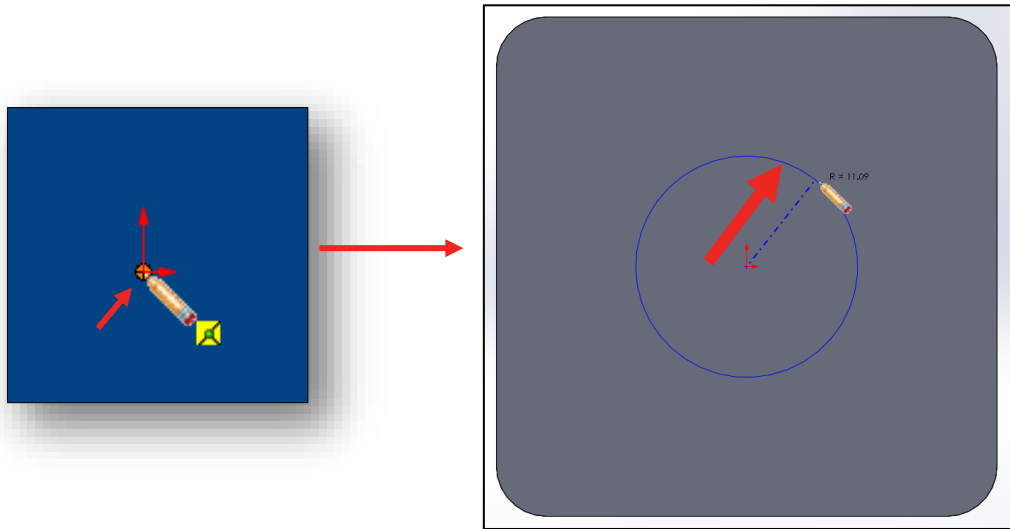

5.

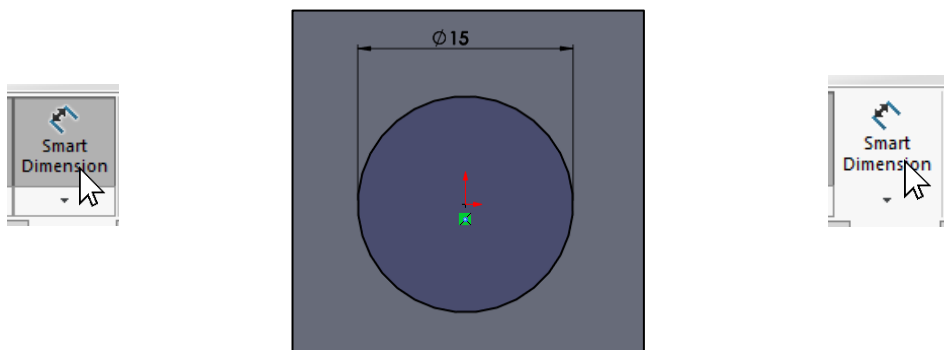

6.

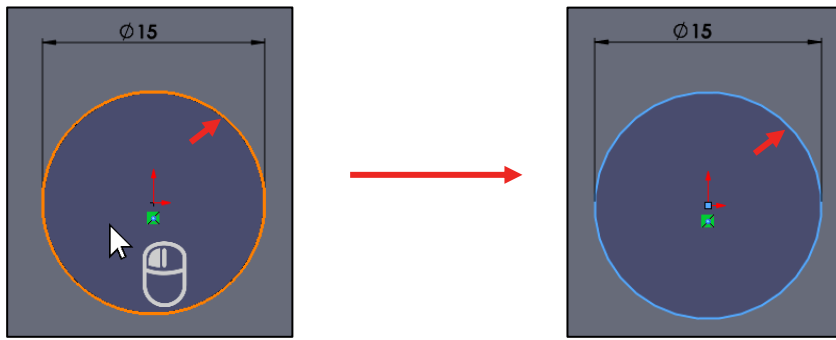

7.

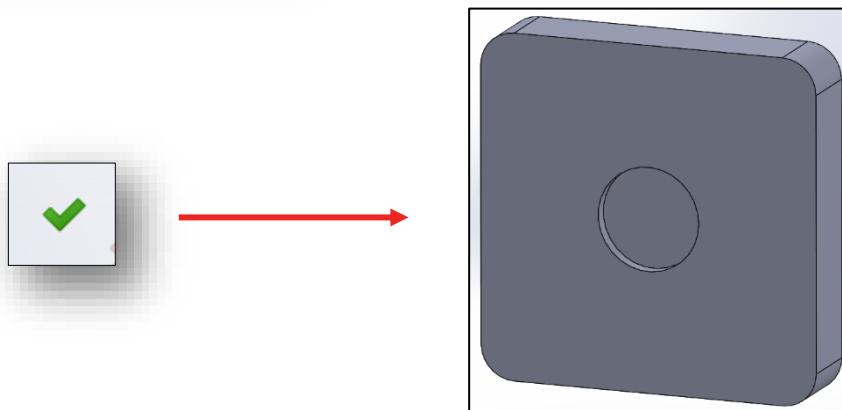
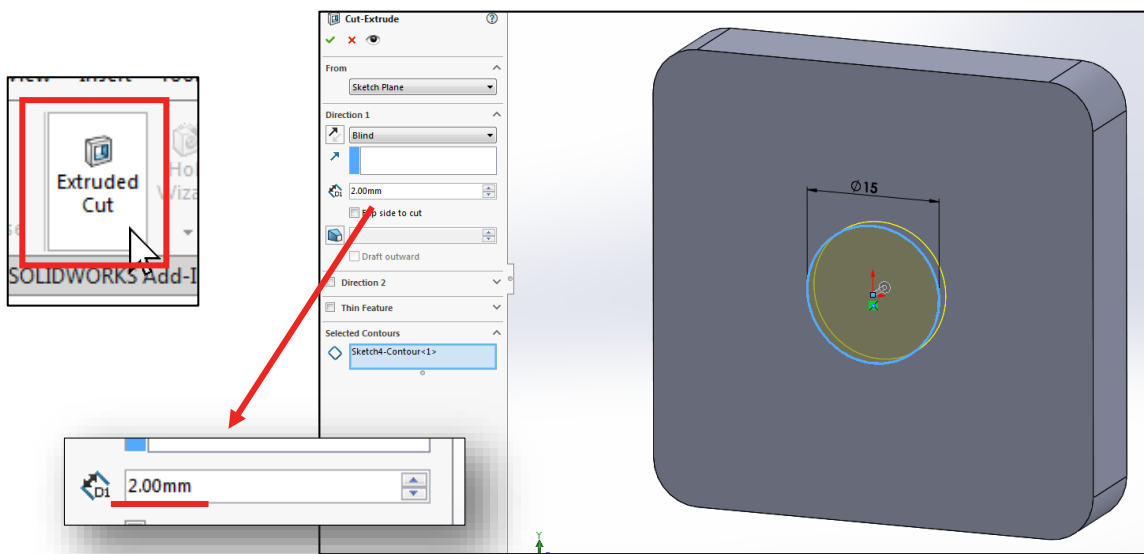

8.

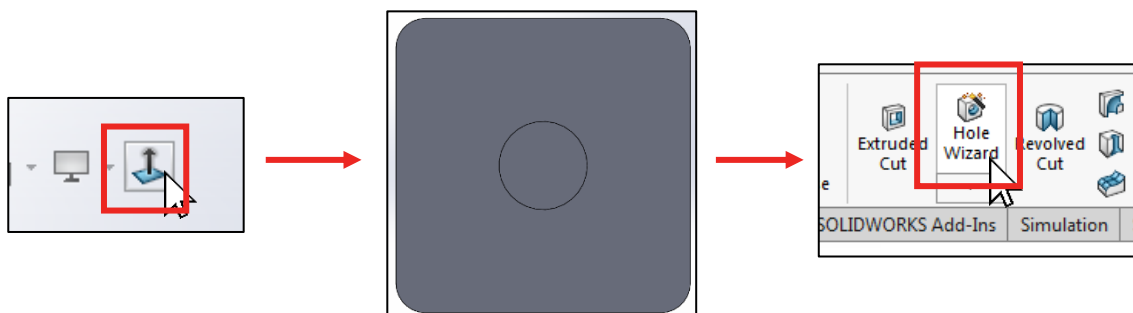

9.

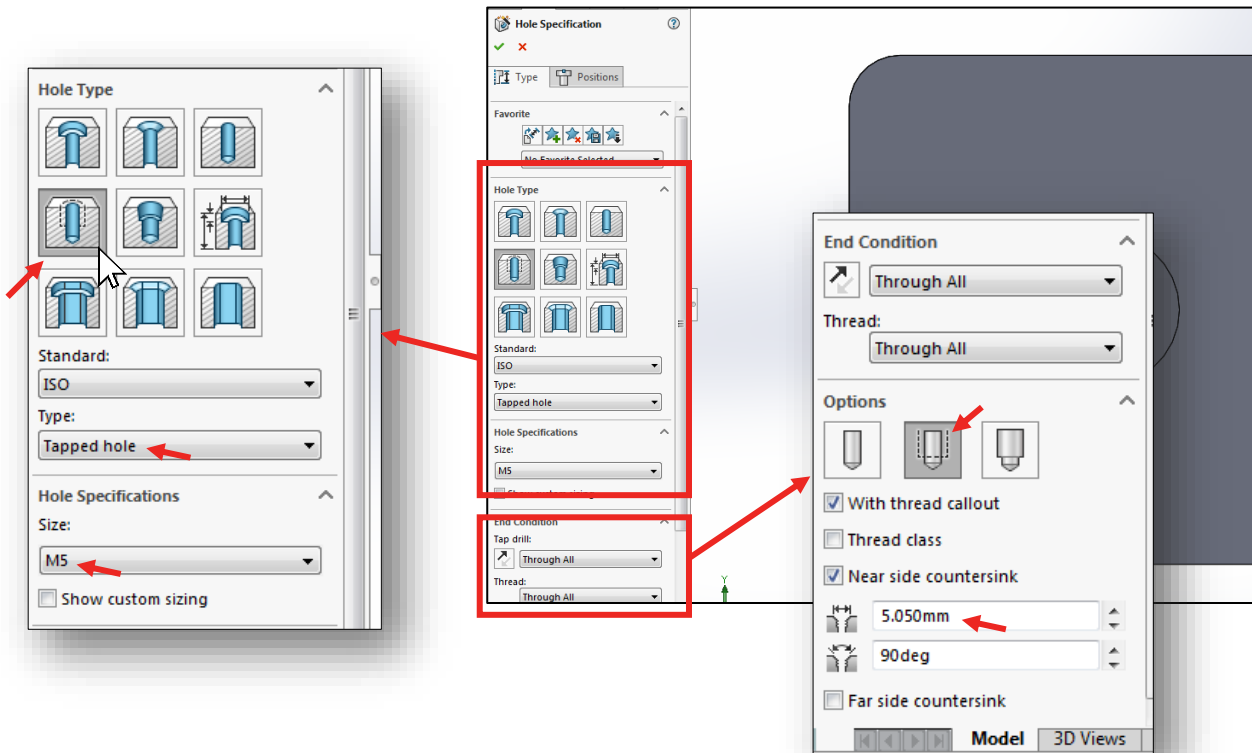

10.

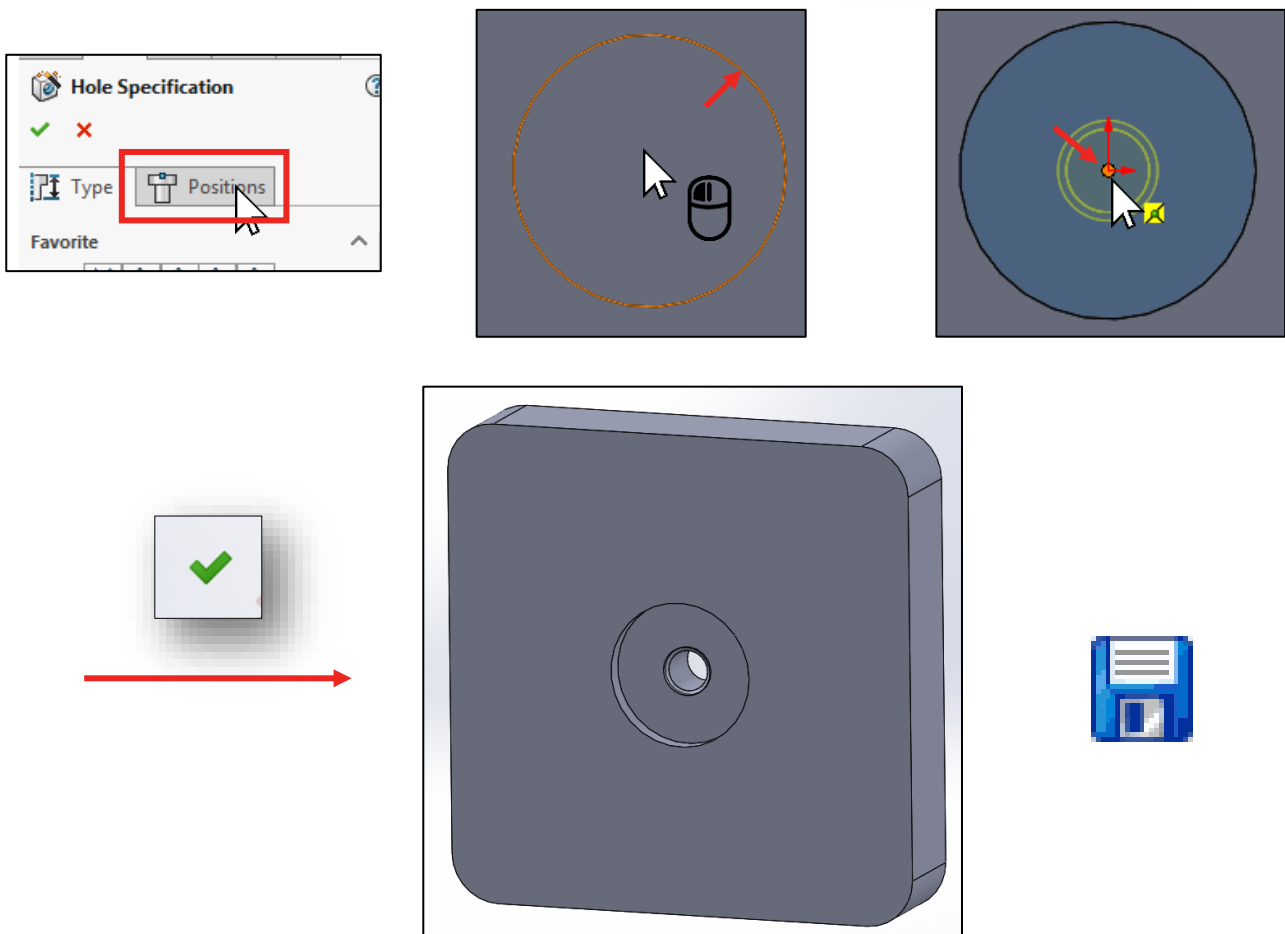

11.

see Project 1
III Nr. 19 - 20

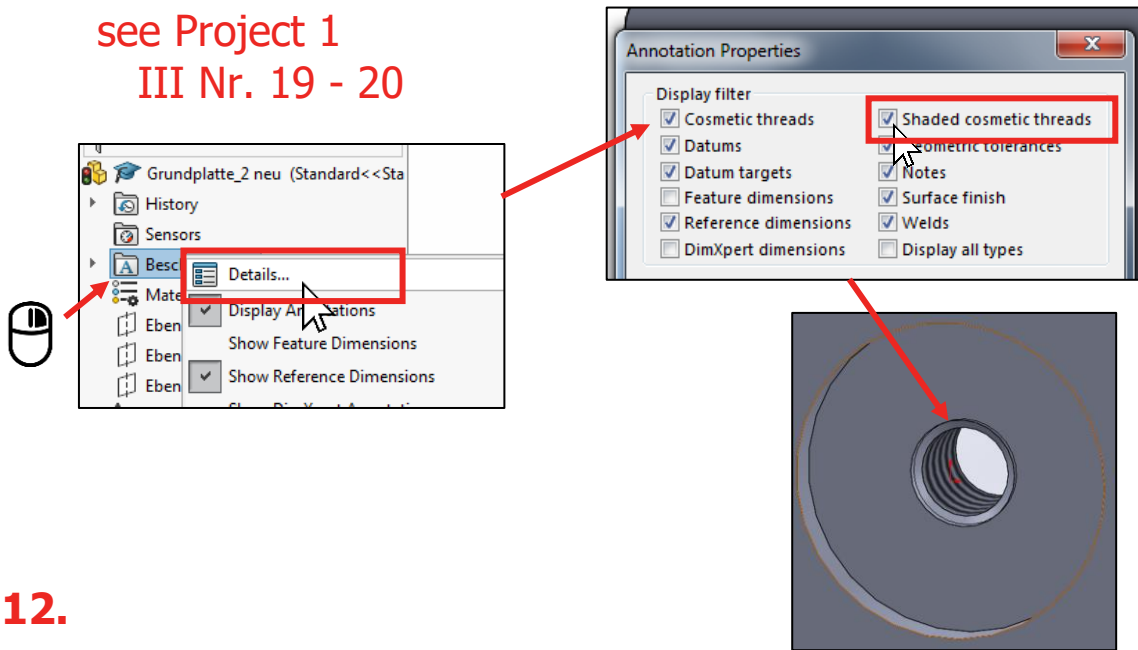

12.

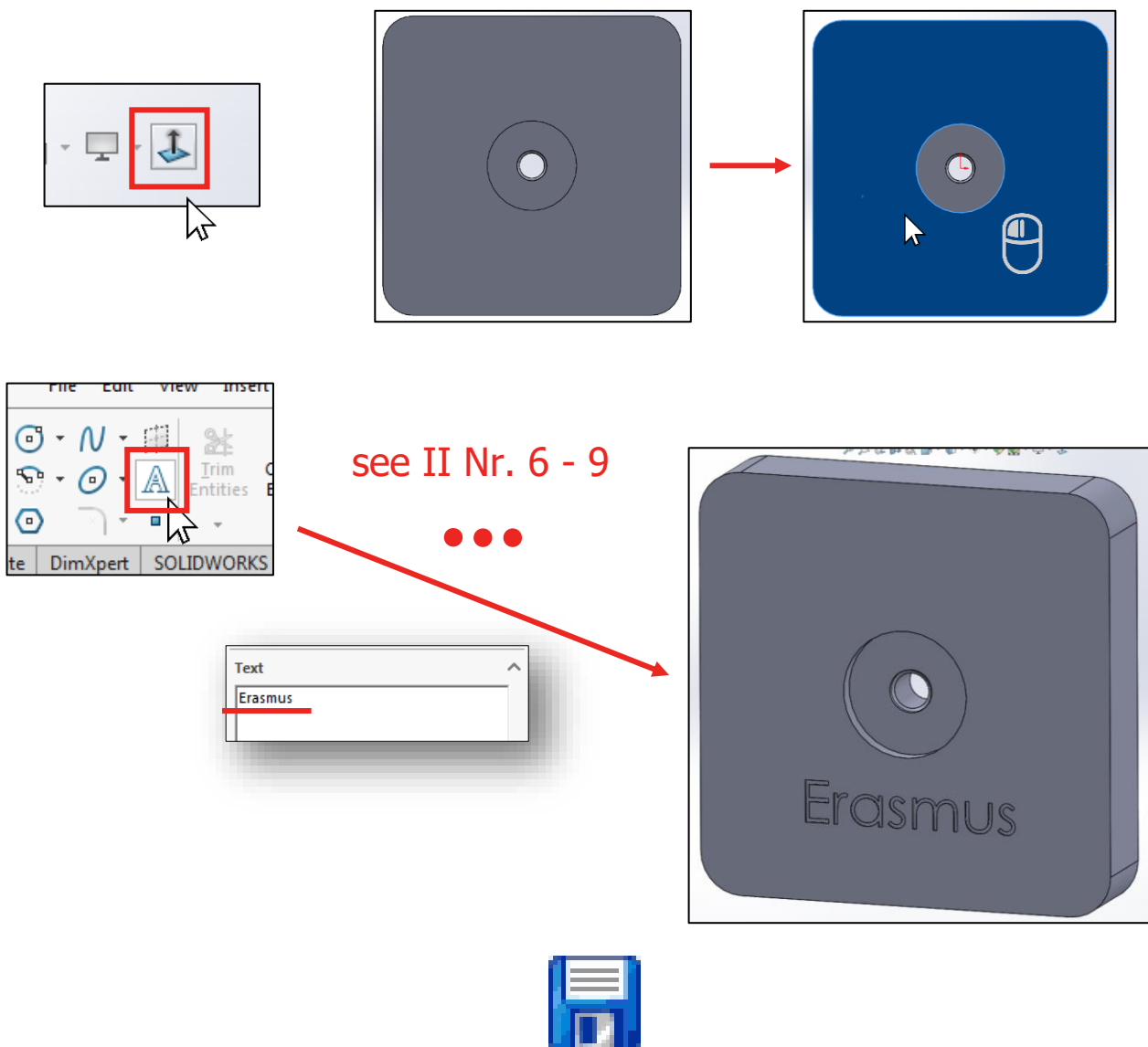

13.

