

## II. Modifying the plate

Reference: **Deckplatte\_2 – Project 3 Holder (3/5)**

1.

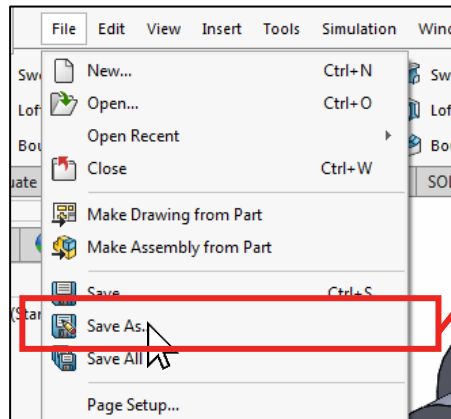
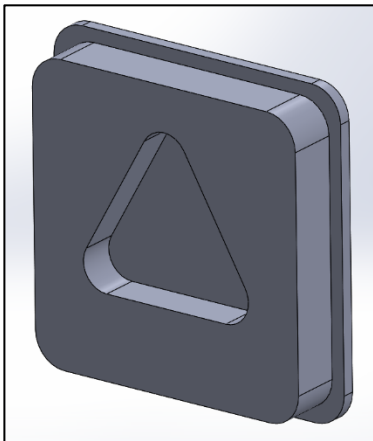

New File!

2.

Variant A

Variant B

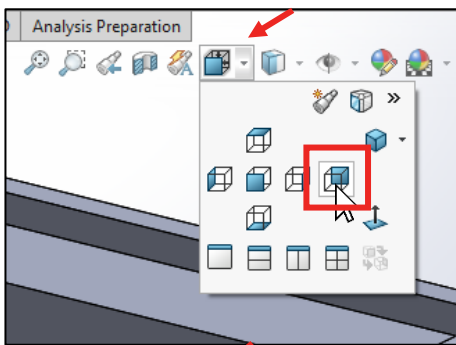

1-2x 

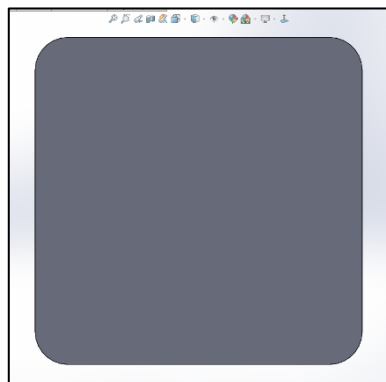

3.

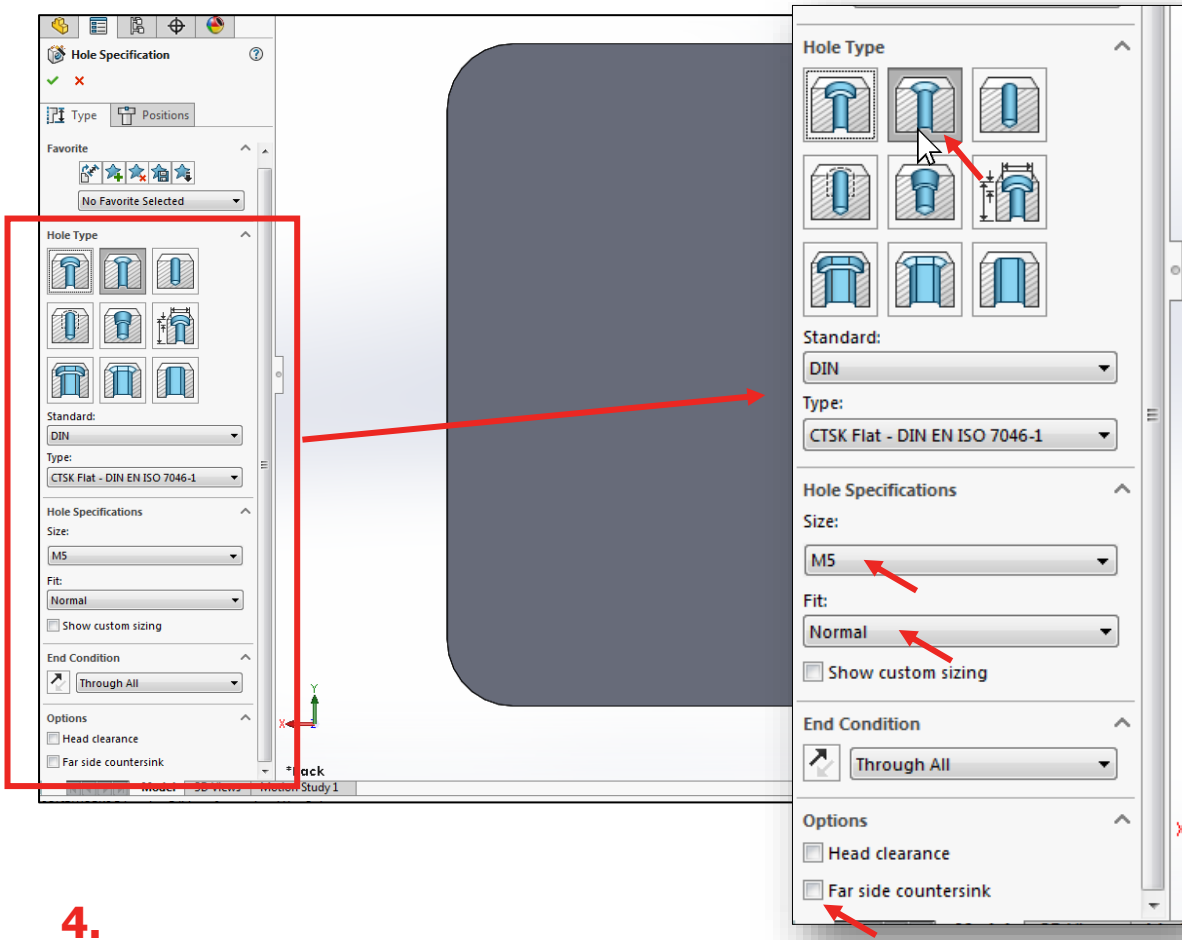
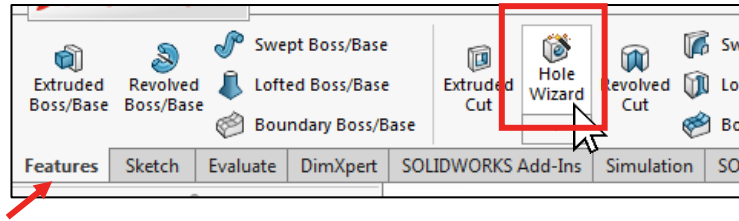

4.

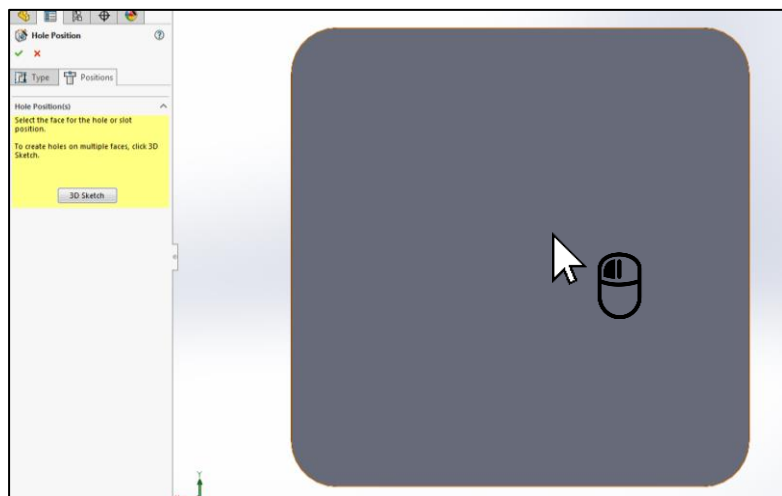
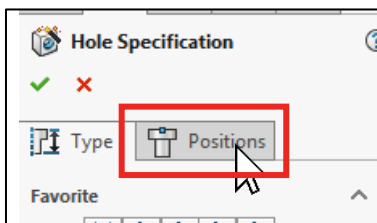

5.

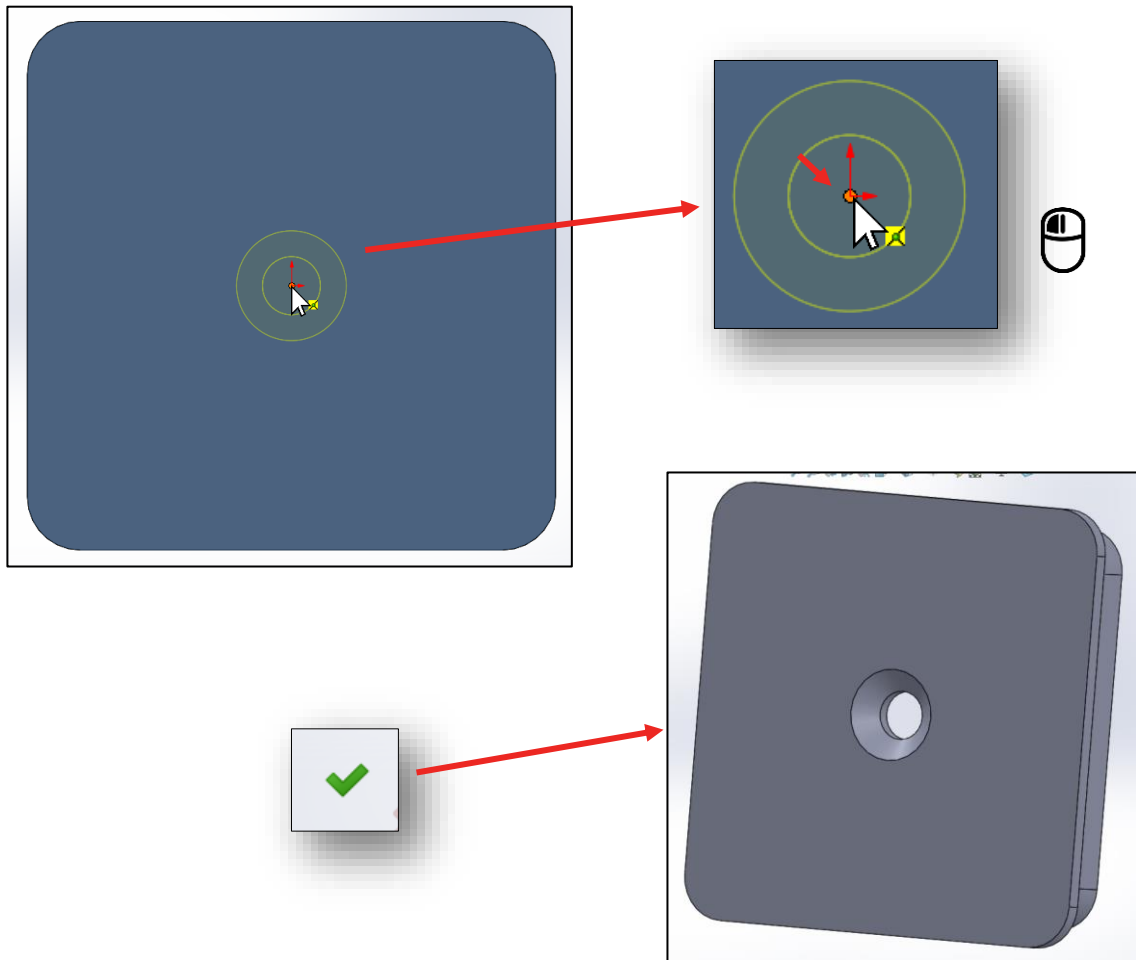

6.

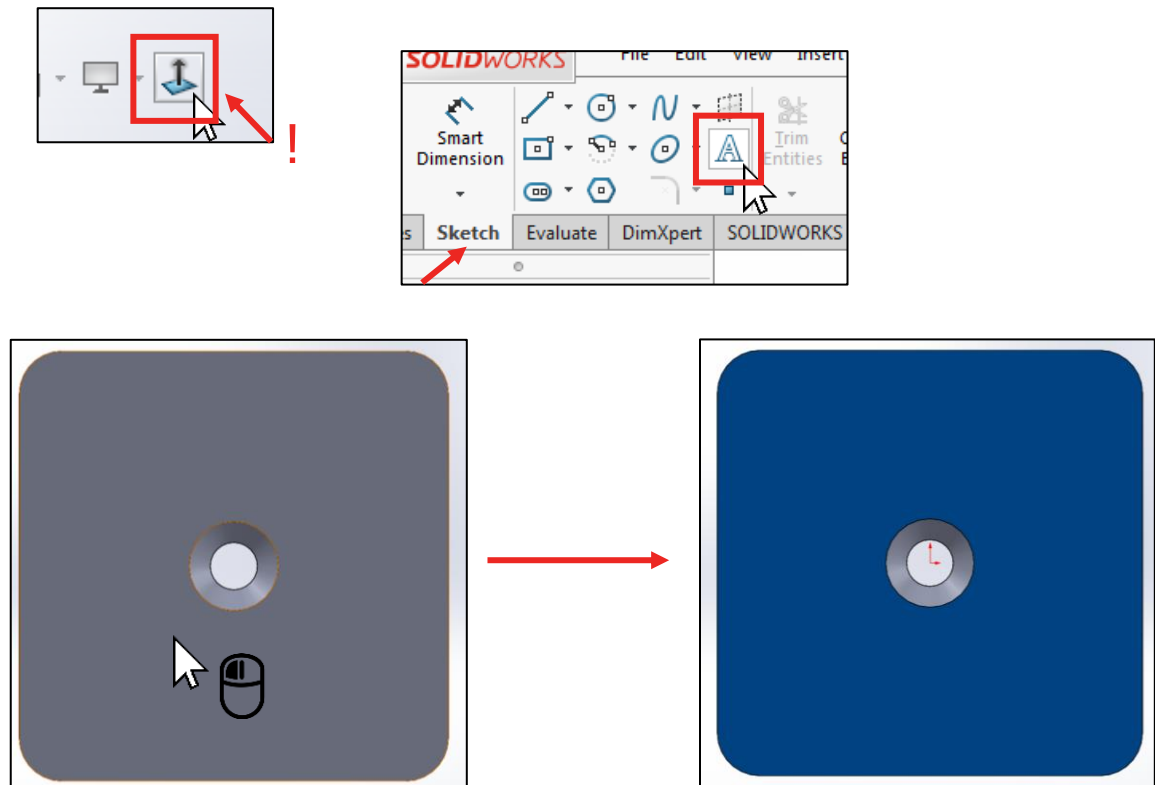

7.

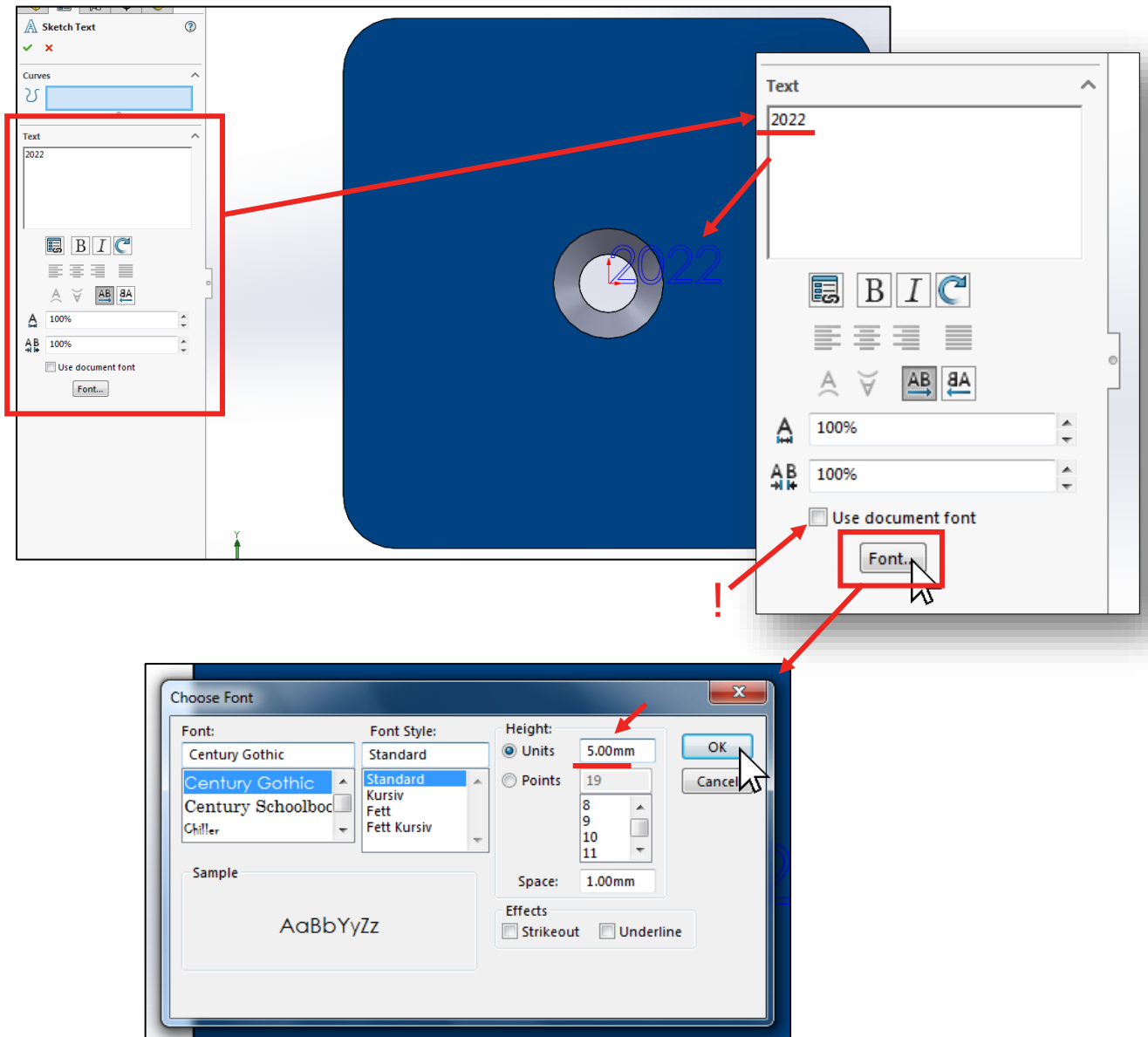

8.

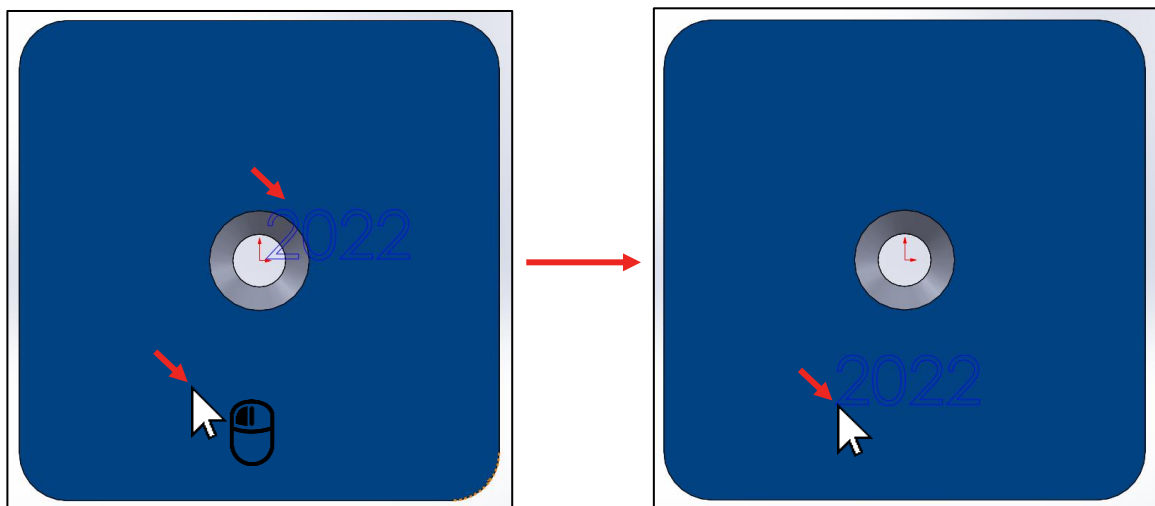

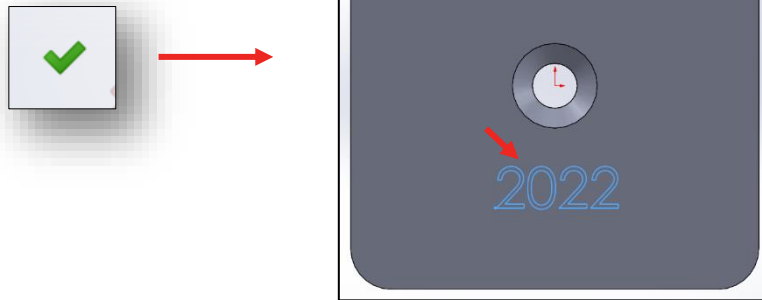

9.

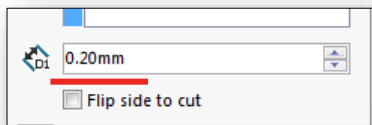
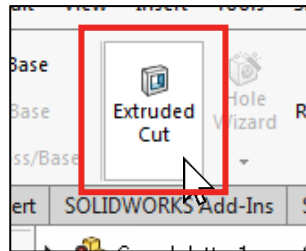

see I Nr. 20



10.

